



## PORTOFOLIU DE PRODUSE

**JORISIDE**  
THE STEEL FUTURE

# JORISIDE

## THE STEEL FUTURE

**Joris Ide** este un producător strategic de panouri din oțel pentru pereți și acoperiș, prezent de peste 30 de ani pe piețele internaționale. Soluțiile noastre se adaptează fiecărui tip de proiect, fie ca vorbim de sectorul industrial, agricol, comercial sau rezidențial, fie că vorbim de construcții noi sau lucrări de renovare. Ele sunt dezvoltate, proiectate și fabricate astfel încât să asigure siguranță, durabilitate, eficiență și performanțe tehnice la cele mai înalte standarde.

Portofoliul nostru de produse cuprinde o gamă largă de profile pentru pereți și acoperiș, panouri sandwich, panouri imitație de țiglă, țigle Perma, profile galvanizate, precum și diferite tipuri de accesorii aferente și pentru porți glisante.

În anul 2015, grupul **Kingspan** a achiziționat integral grupul **Joris Ide** din care face parte și **Joris Ide România**.

### CONTACT

MUNTENIA	Ciprian Holban	+40 726 204 161
	Claudiu Sprințeană	+40 752 164 891
	Sebastian Dragomir	+40 756 077 419
BANAT	Adina Cosovan	+40 722 403 168
	Ovidiu Unchesu	+40 756 076 512
	Marcela Holodinschi	+40 752 142 682
OLTENIA	Iulian Zamfir	+40 752 102 284
	Bogdan Guna	+40 758 066 885
MOLDOVA	Cosmin Archip	+40 744 334 847
	Ionut Savin	+40 724 323 996
	Roxana Oneagă	+40 756 076 518
	Ovidiu Dragomir	+40 726 333 929
R.MOLDOVA	Victor Popa	+37 36 822 3220
TRASILVANIA	Bogdan Puiu	+40 751 070 386
	Gabriel Naznean	+40 751 085 406
	Octavian Marele	+40 724 298 246
UNGARIA	Gabor Galambos	+36 303 269 151
SERBIA	Iota Buzarski	+40 727 737 270

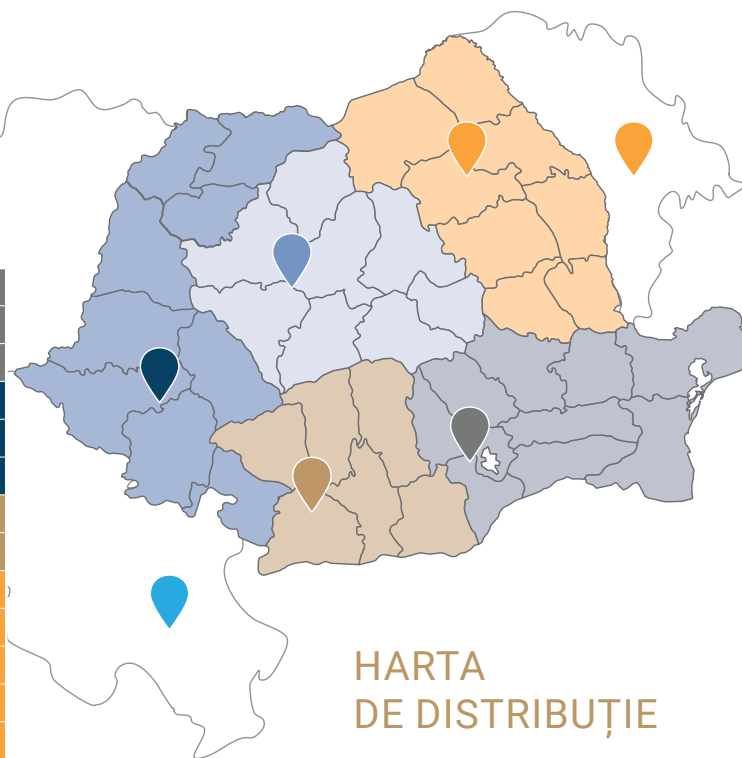



## CUPRINS

<b>TABLĂ CUTATĂ</b>	<b>03</b>
Tablă cutată perete.....	03
Tablă cutată acoperiș.....	05
Tablă cutată planșee și placare pereți interiori.....	07
Tablă cutată OPTIQUE.....	07
Tablă cutată înaltă - acoperișuri plane.....	07
Tablă cutată PLANCHE.....	09
<b>PANOURI SANDWICH</b>	<b>10</b>
Panouri de acoperiș.....	10
Panouri de perete .....	11
Profile disponibile panouri de perete VM - SF .....	13
Profile disponibile panouri de perete VM - NF .....	15
Profile disponibile panouri de perete PIR - SF .....	17
Profile disponibile panouri de perete PIR - NF .....	19
<b>ACCESORII</b>	<b>21</b>
Accesorii de etanșare și izolare.....	21
Luminatoare.....	22
Accesorii metalice de finisaj.....	23
Sistem pluvial.....	25

# TABLĂ CUTATĂ PERETE



**JIS 8-116,5-1165\***

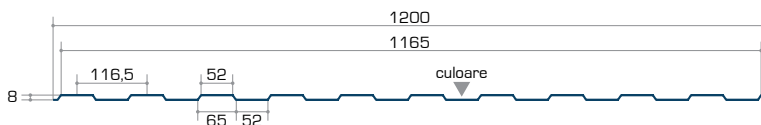

GROSIME (mm)	GREUTATE (kg/m <sup>2</sup> )
0,40	3,92
0,45	3,76
0,50	4,7
0,60	4,59



**JIS 10-138-1100\*\***

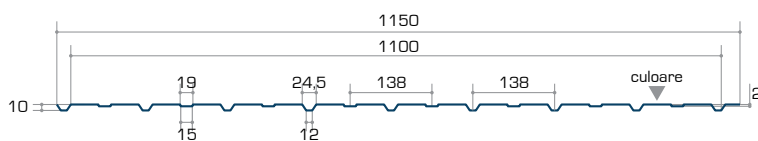

GROSIME (mm)	GREUTATE (kg/m <sup>2</sup> )
0,40	3,92
0,45	3,76
0,50	4,17
0,60	4,59
0,75	6,24



**JIS 16,5-137,5-1100**

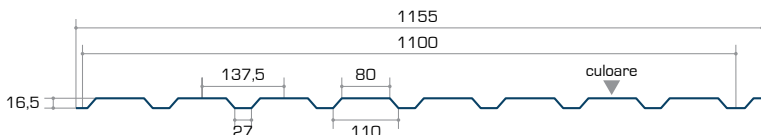

GROSIME (mm)	GREUTATE (kg/m <sup>2</sup> )
0,40	3,58
0,45	4,04
0,50	4,48
0,60	4,93



**JIS 18-135-1080**

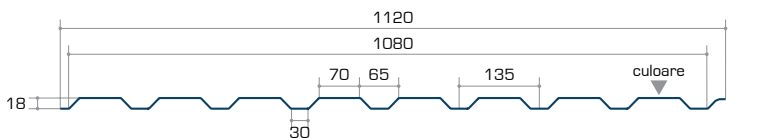

GROSIME (mm)	GREUTATE (kg/m <sup>2</sup> )
0,40	3,58
0,45	4,04
0,50	4,48
0,60	4,93

\*Acest profil se găsește și pe varianta scurtă de 930 mm.

\*\*Acest profil se găsește și pe varianta scurtă de 828 mm.

# TABLĂ CUTATĂ PERETE



**J1 18-076-988 (sinus)**

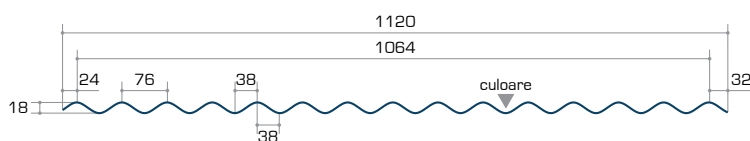

GROSIME (mm)	GREUTATE (kg/m <sup>2</sup> )
0,40	3,97
0,45	4,46
0,50	4,96
0,60	5,45
0,75	7,14

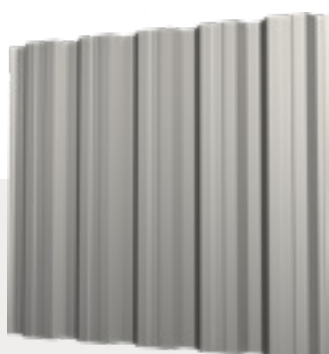

**JIS 35-207-1035**

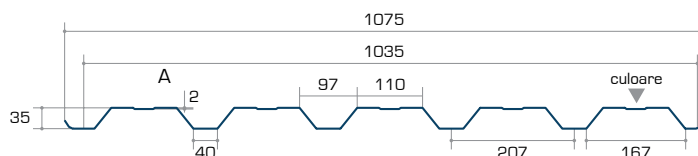

GROSIME (mm)	GREUTATE (kg/m <sup>2</sup> )
0,40	3,81
0,45	4,29
0,50	4,76
0,60	5,24
0,75	7,12



**JIS 38-250-1000**

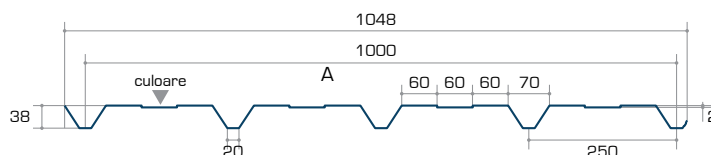

GROSIME (mm)	GREUTATE (kg/m <sup>2</sup> )
0,40	3,94
0,45	4,44
0,50	4,92
0,60	5,42
0,75	7,34



**J1 45-333-1000**

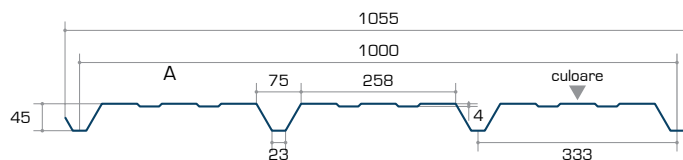

GROSIME (mm)	GREUTATE (kg/m <sup>2</sup> )
0,40	3,94
0,45	4,44
0,50	4,92
0,60	5,42
0,75	7,37

# TABLĂ CUTATĂ ACOPERIȘ



**JIS 16,5-137,5-1100**

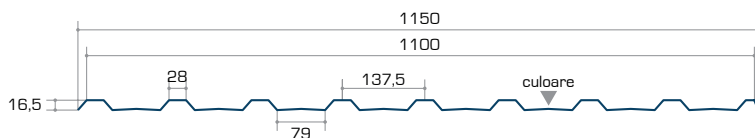

GROSIME (mm)	GREUTATE (kg/m <sup>2</sup> )
0,35	3,16
0,40	3,58
0,50	4,48
0,60	4,92



**JIS 18-135-1080**

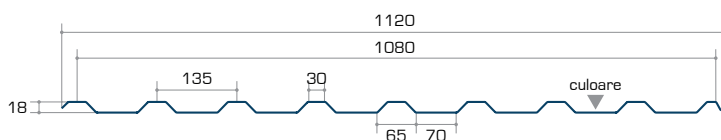

GROSIME (mm)	GREUTATE (kg/m <sup>2</sup> )
0,35	3,16
0,40	3,58
0,50	4,48
0,60	4,92
0,75	7,12



**J1 18-076-988 (sinus)**

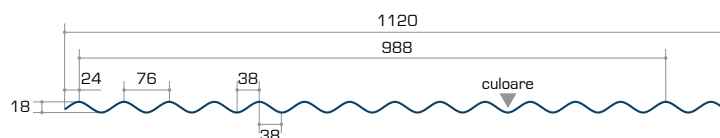

GROSIME (mm)	GREUTATE (kg/m <sup>2</sup> )
0,40	3,97
0,45	4,46
0,50	4,96
0,60	5,45
0,75	7,14

# TABLĂ CUTATĂ ACOPERIȘ



**JIS 35-207-1035**

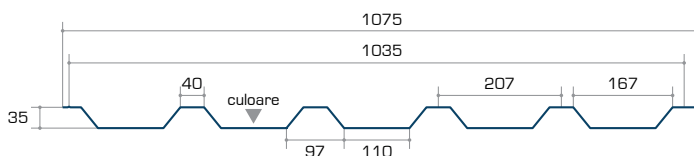

GROSIME (mm)	GREUTATE (kg/m <sup>2</sup> )
0,35	3,44
0,40	3,81
0,45	4,29
0,50	4,76
0,60	4,92
0,75	7,12



**JIS 38-250-1000**

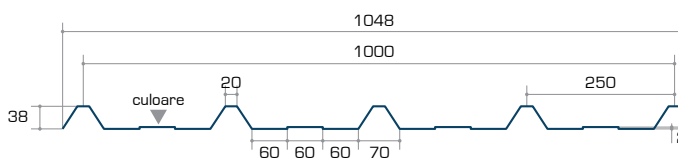

GROSIME (mm)	GREUTATE (kg/m <sup>2</sup> )
0,35	3,44
0,40	3,94
0,45	4,44
0,50	4,92
0,60	4,92
0,75	7,34



**Jl 45-333-1000**

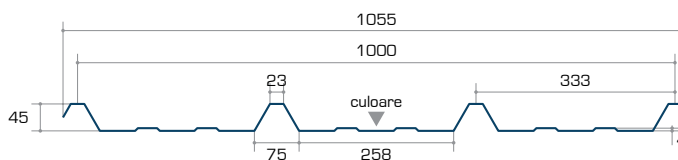

GROSIME (mm)	GREUTATE (kg/m <sup>2</sup> )
0,35	3,44
0,40	3,94
0,45	4,44
0,50	4,92
0,60	4,92
0,75	7,34

# TABLĂ CUTATĂ

Planșe și placare pereți interiori

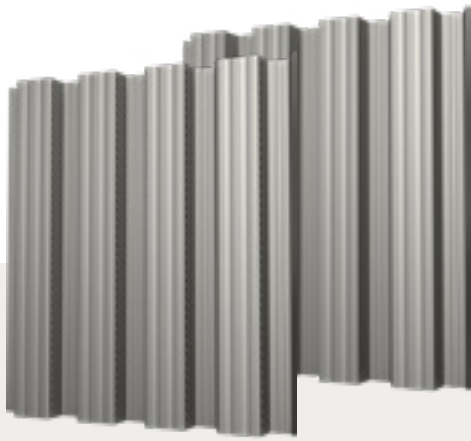

JIS 58-205-820

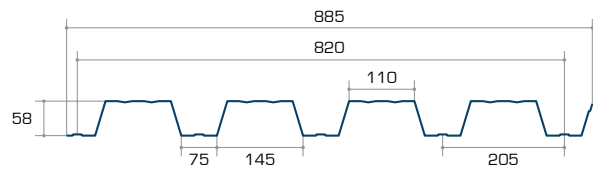

GROSIME (mm)	GREUTATE (kg/m <sup>2</sup> )
0,75	8,77
1,00	11,28

Se utilizează ca și cofrag pierdut doar galvanizat.  
Profilul prezintă ambutisări pe cute.

# TABLĂ CUTATĂ

OPTIQUE



JIS OPTIQUE

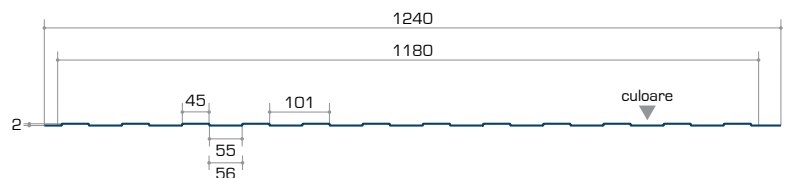

GROSIME (mm)	GREUTATE (kg/m <sup>2</sup> )
0,35	3,16
0,40	3,58
0,50	4,48
0,60	4,92

# TABLĂ CUTATĂ ÎNALTĂ

## ACOPERIȘURI PLANE



**JIS 85-280-1120**

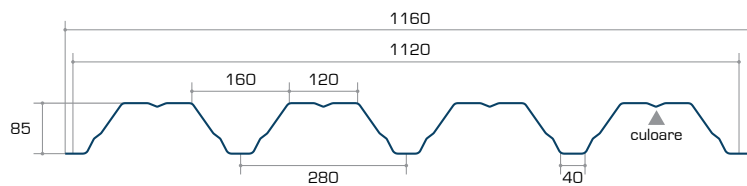

GROSIME (mm)	GREUTATE (kg/m <sup>2</sup> )
0,75	10,10
0,88	11,83
1,00	13,43
1,25	15,16



**JIS 153-280-840**

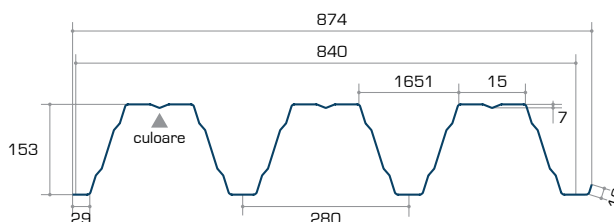

GROSIME (mm)	GREUTATE (kg/m <sup>2</sup> )
0,75	10,61
0,88	12,43
1,00	14,11
1,25	17,61



**JIS 200-420-840**

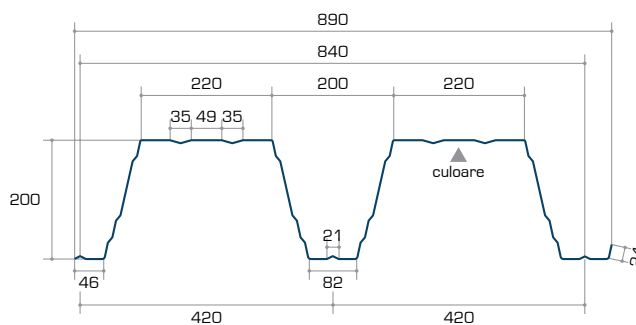

GROSIME (mm)	GREUTATE (kg/m <sup>2</sup> )
0,75	10,61
0,88	12,43
1,00	14,11
1,25	17,61

# TABLĂ CUTATĂ

## PLANCHE



JIS PLANCHE

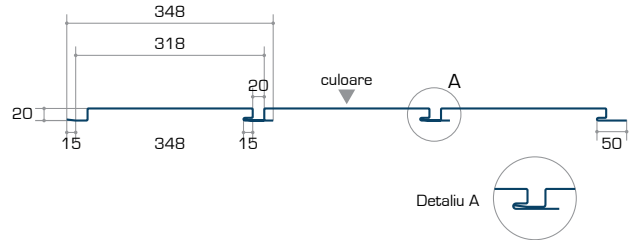

Dimensiune maximă  
6 m

### MONTARE

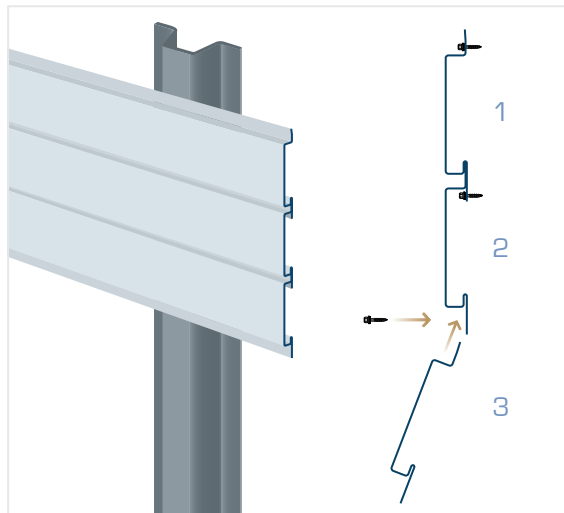

### PROFILE DE FINISARE | PLIERE PERSONALIZATĂ

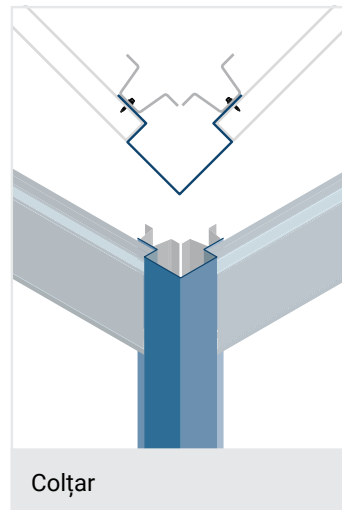
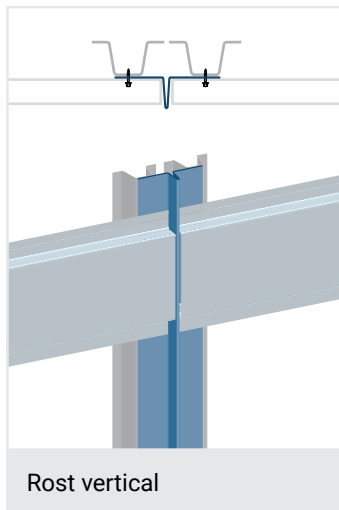
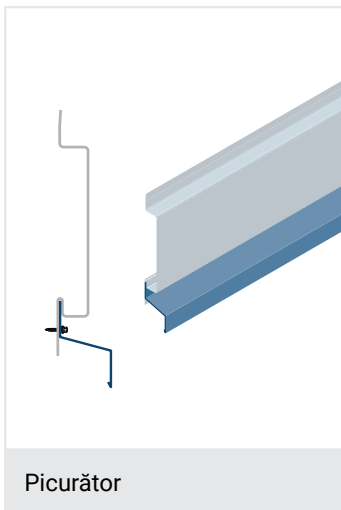

# PANOURI SANDWICH DE ACOPERIȘ



**PANOU PIR ACOPERIȘ 4 CUTE**

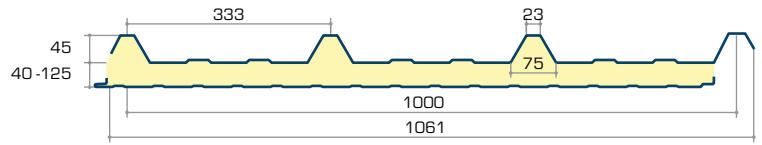

GROSIME (mm)	GREUTATE (kg/m <sup>2</sup> )	REZISTENȚA LA FOC (min.)
40	9,93	REI 15
50	10,44	REI 20
60	10,72	REI 30
80	11,48	REI 20*
100	12,30	REI 60
125	13,33	REI 45

\* încărcare de 50 kg



**PANOU VATĂ MINERALĂ ACOPERIȘ**

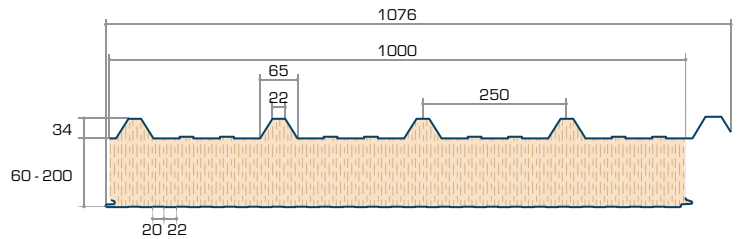

GROSIME (mm)	GREUTATE (kg/m <sup>2</sup> )	REZISTENȚA LA FOC (min.)
60	16,18	REI 60
80	18,18	REI 60
100	20,18	REI 120
120	22,18	REI 180
150	25,18	REI 180
200	30,18	-



**PANOU JIS AGRO ROOF 1000**

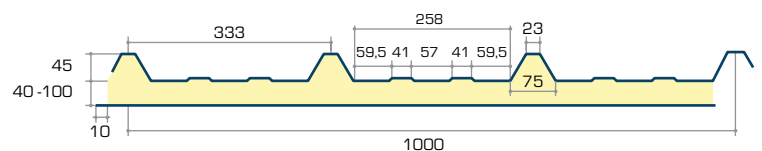

GROSIME (mm)	GREUTATE (kg/m <sup>2</sup> )
30	7,15
40	7,55
60	8,34
100	10,72

# PANOURI SANDWICH DE PERETE



**PANOU PIR PERETE**  
FIXARE ASCUNSĂ

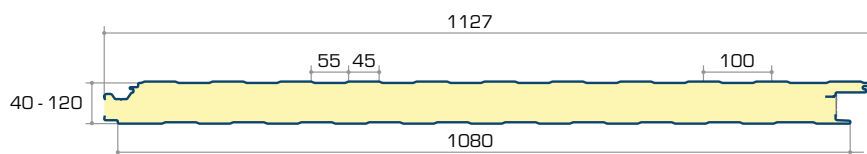

GROSIME (mm)	GREUTATE (kg/m <sup>2</sup> )	REZISTENȚA LA FOC (min.)
40	9,93	-
50	10,44	-
60	10,72	EI 20
80	11,48	EI 20
100	12,30	EI 30* / EI 60**
120	13,74	EI 30* / EI 60**

\* orizontal / \*\* vertical

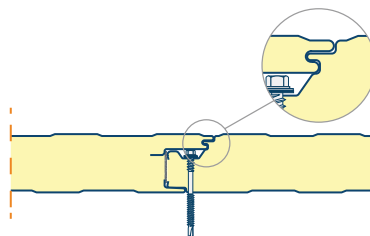

**PANOU PIR PERETE**  
FIXARE VIZIBILĂ

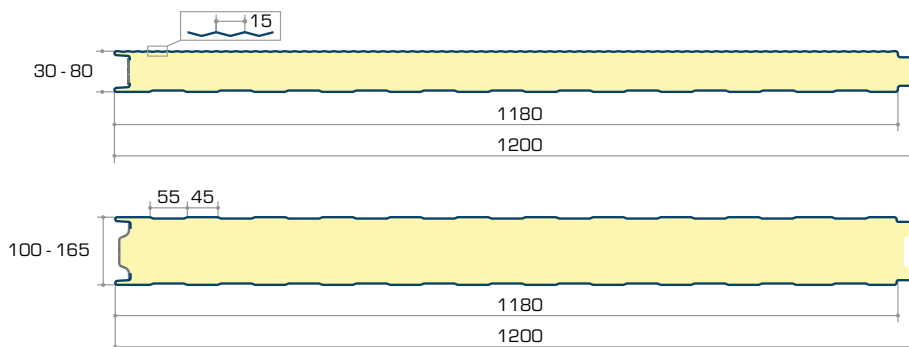

GROSIME (mm)	GREUTATE (kg/m <sup>2</sup> )	REZISTENȚA LA FOC (min.)
30	9,34	-
40	9,93	EI 15
50	10,44	EI 15
60	10,72	EI 20
80	11,43	EI 20
100	12,30	EI 30
120	13,74	EI 30
150	14,94	EI 30
165	15,51	EI 30



# PANOURI SANDWICH DE PERETE



**PANOU VATĂ MINERALĂ PERETE  
FIXARE ASCUNSĂ**

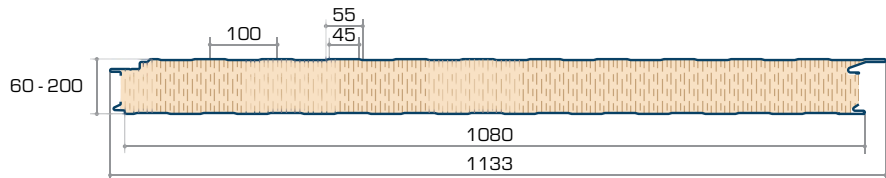

GROSIME (mm)	GREUTATE (kg/m <sup>2</sup> )	REZISTENȚA LA FOC (min.)
60	17,44	EI 30
80	19,80	EI 45* / EI 60**
100	22,16	EI 45* / EI 60**
120	24,52	EI 120* / EI 60**
150	28,06	EI 180* / EI 60**
180	31,67	EI 180* / EI 60**
200	33,96	EI 180* / EI 60**

\* orizontal / \*\* vertical

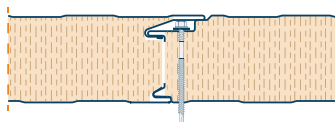

**PANOU VATĂ MINERALĂ PERETE  
FIXARE VIZIBILĂ**

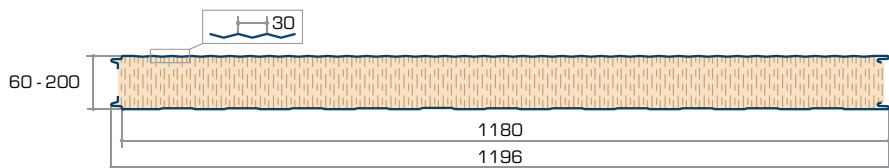

GROSIME (mm)	GREUTATE (kg/m <sup>2</sup> )	REZISTENȚA LA FOC (min.)
60	17,44	EI 30
80	19,80	EI 45* / EI 60**
100	22,16	EI 90* / EI 120**
120	24,52	EI 120* / EI 180**
150	28,06	EI 120* / EI 180**
180	31,67	EI 120* / EI 180**
200	33,96	EI 120* / EI 180**

\* orizontal / \*\* vertical

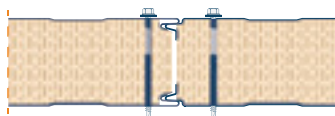

# PANOURI SANDWICH VATĂ MINERALĂ

DE PERETE - profile disponibile



**PANOU VATĂ MINERALĂ PERETE**  
FIXARE ASCUNSĂ M-O (micro-optic)

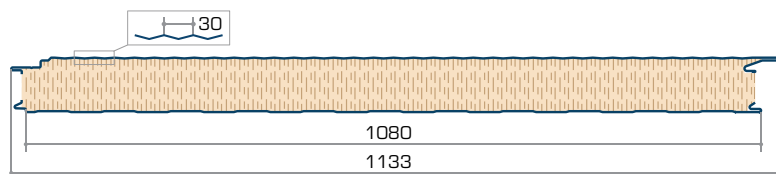

**PANOU VATĂ MINERALĂ PERETE**  
FIXARE ASCUNSĂ L-O (lis-optic)

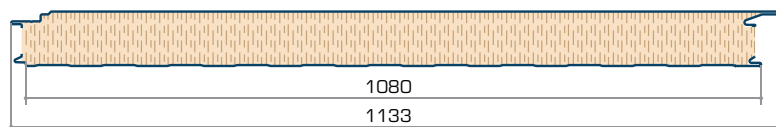

**PANOU VATĂ MINERALĂ PERETE**  
FIXARE ASCUNSĂ O-O (optic-optic)

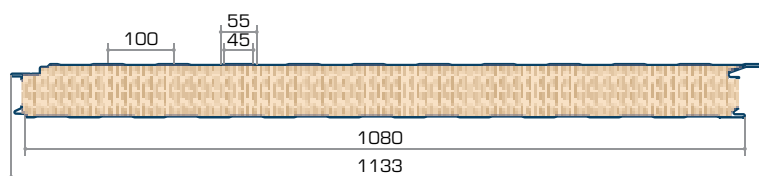

# PANOURI SANDWICH VATĂ MINERALĂ

DE PERETE - profile disponibile



**PANOU VATĂ MINERALĂ PERETE**  
FIXARE ASCUNSĂ O-L (optic-lis)

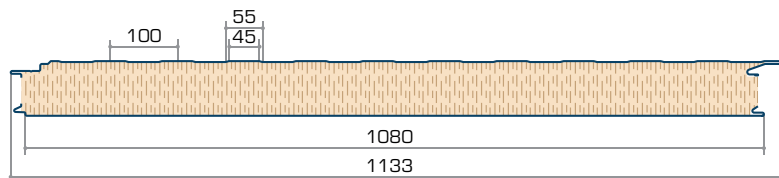

**PANOU VATĂ MINERALĂ PERETE**  
FIXARE ASCUNSĂ M-L (micro-lis)

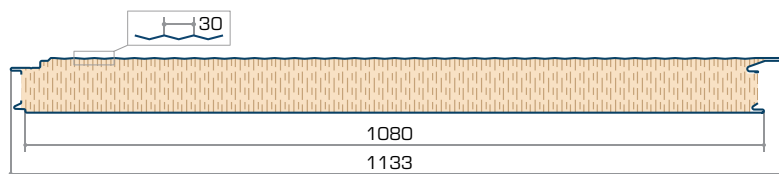

**PANOU VATĂ MINERALĂ PERETE**  
FIXARE ASCUNSĂ L-L (lis-lis)

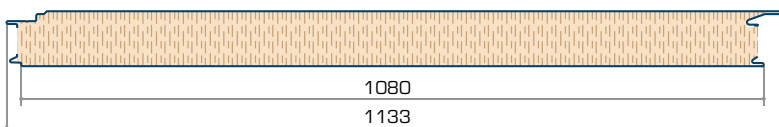

# PANOURI SANDWICH VATĂ MINERALĂ

DE PERETE - profile disponibile



**PANOU VATĂ MINERALĂ PERETE**  
FIXARE VIZIBILĂ M-O (micro-optic)

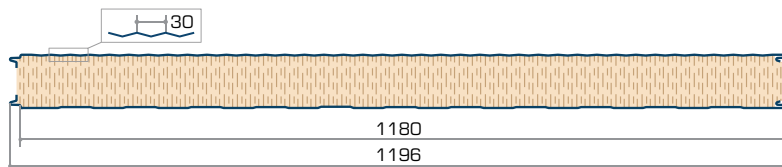

**PANOU VATĂ MINERALĂ PERETE**  
FIXARE VIZIBILĂ L-O (lis-optic)

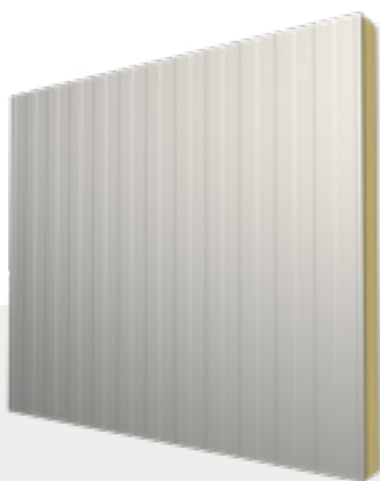
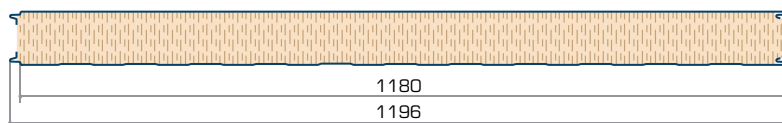

**PANOU VATĂ MINERALĂ PERETE**  
FIXARE VIZIBILĂ O-O (optic-optic)

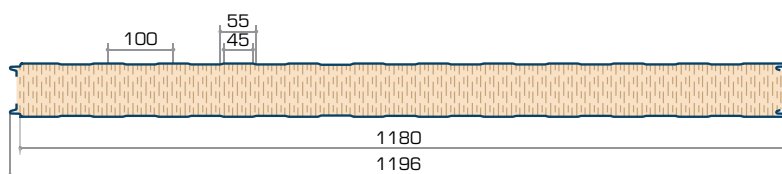

# PANOURI SANDWICH VATĂ MINERALĂ

DE PERETE - profile disponibile

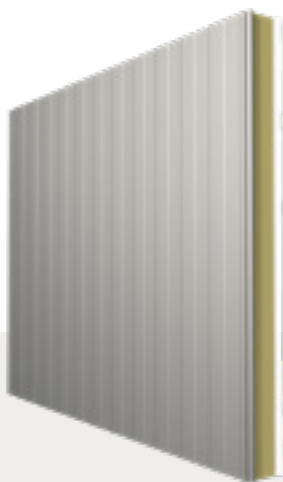

**PANOU VATĂ MINERALĂ PERETE**  
FIXARE VIZIBILĂ O-L (optic-lis)

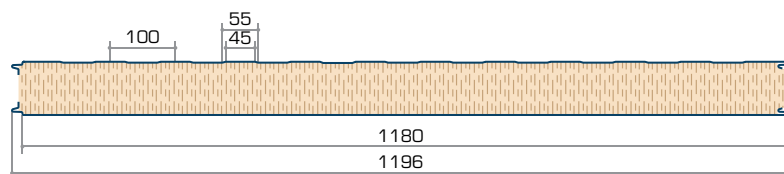

**PANOU VATĂ MINERALĂ PERETE**  
FIXARE VIZIBILĂ M-L (micro-lis)

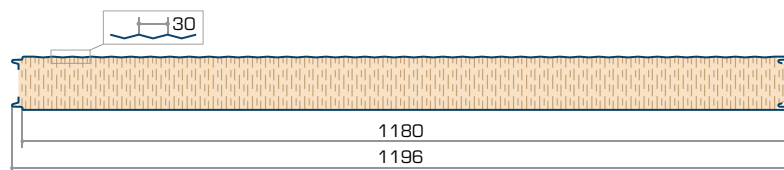

**PANOU VATĂ MINERALĂ PERETE**  
FIXARE VIZIBILĂ L-L (lis-lis)

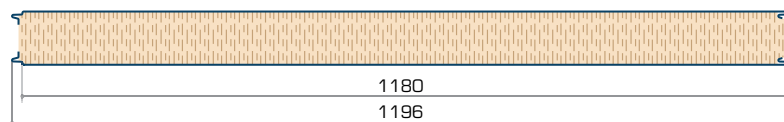

# PANOURI SANDWICH PIR

## DE PERETE - profile disponibile



**PANOU PIR PERETE**  
FIXARE ASCUNSĂ M-O (micro-optic)

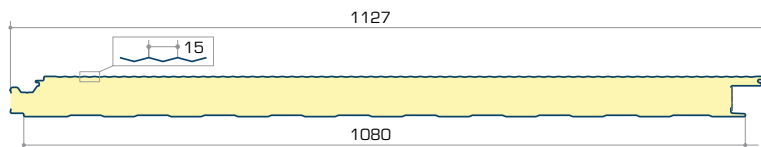

**PANOU PIR PERETE**  
FIXARE ASCUNSĂ L-O (lis-optic)

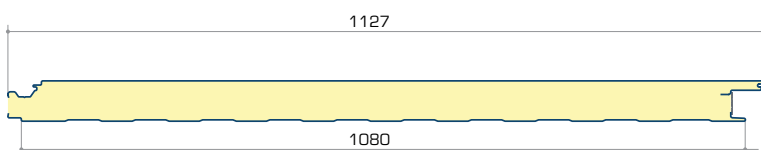

**PANOU PIR PERETE**  
FIXARE ASCUNSĂ O-O (optic-optic)

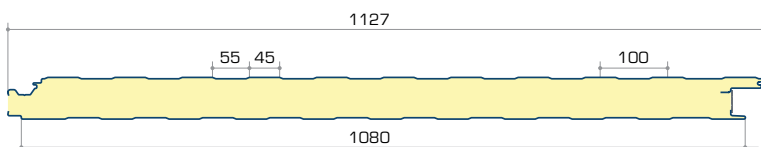

# PANOURI SANDWICH PIR

## DE PERETE - profile disponibile



**PANOU PIR PERETE**  
FIXARE ASCUNSĂ O-L (optic-lis)

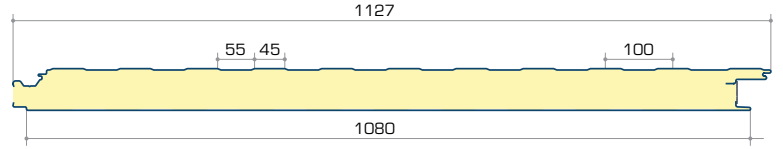

**PANOU PIR PERETE**  
FIXARE ASCUNSĂ M-L (micro-lis)

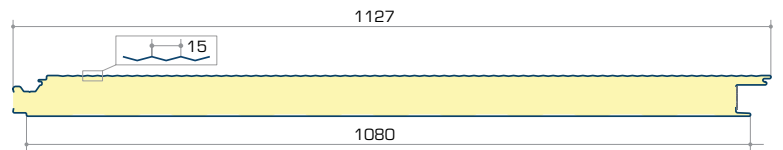

**PANOU PIR PERETE**  
FIXARE ASCUNSĂ L-L (lis-lis)

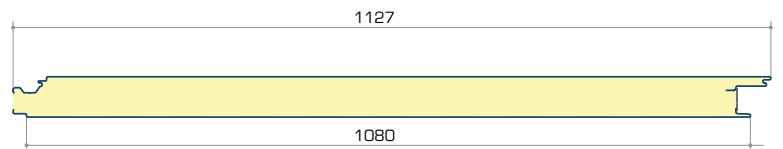

# PANOURI SANDWICH PIR

## DE PERETE - profile disponibile

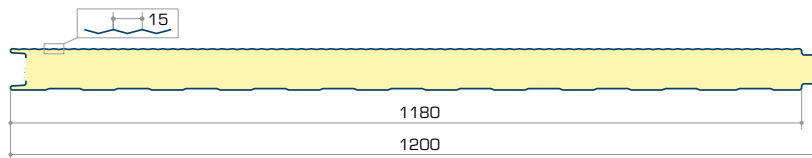

**PANOU PIR PERETE**  
FIXARE VIZIBILĂ M-O (micro-optic)

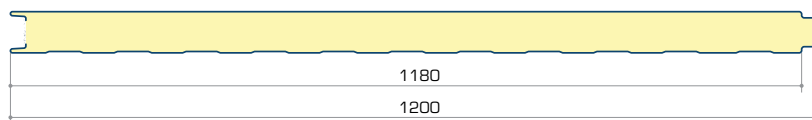

**PANOU PIR PERETE**  
FIXARE VIZIBILĂ L-O (lis-optic)

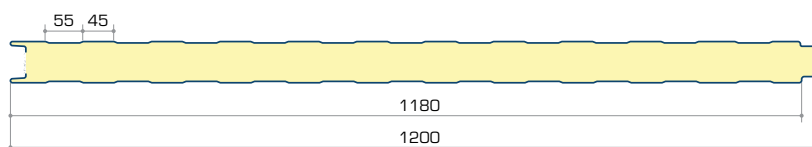

**PANOU PIR PERETE**  
FIXARE VIZIBILĂ O-O (optic-optic)

# PANOURI SANDWICH PIR

## DE PERETE - profile disponibile

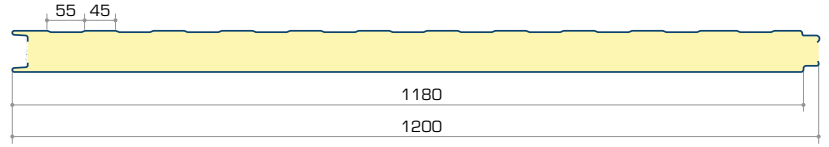

**PANOU PIR PERETE**  
FIXARE VIZIBILĂ O-L (optic-lis)

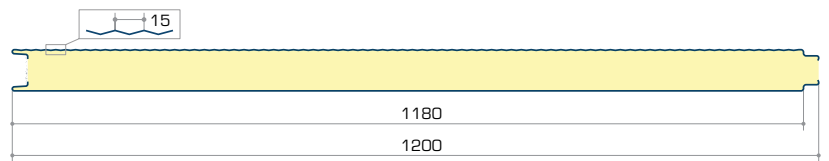

**PANOU PIR PERETE**  
FIXARE VIZIBILĂ M-L (micro-lis)

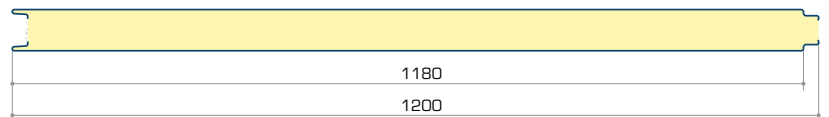

**PANOU PIR PERETE**  
FIXARE VIZIBILĂ L-L (lis-lis)

# ACCESORII

de etanșare și izolare



**ROLĂ ADEZIVĂ IZOBUTYL**  
(15 mm x 60 ml)



**MANȘOANE ETANȘARE**  
D60 mm – D475 mm



**SILICON**  
AQUAFIX



**BANDĂ UNIVERSALĂ**  
AUTOADEZIVĂ (DOLIE)

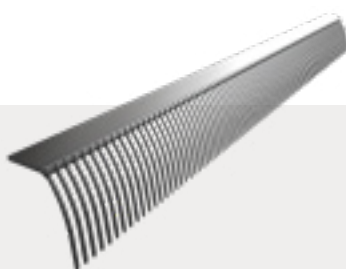

**PIEPTEN PLĂSTIC**  
ANTI-PĂSĂRI



**VOPSEA**  
DE RETUȘ

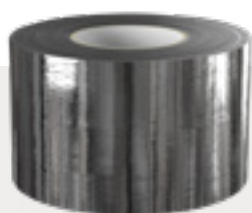

**ALUBAND**  
(100 mm / 150 mm / 300 mm x 10 ml)



**ROLĂ ETANȘARE HORN**  
IZOLEN

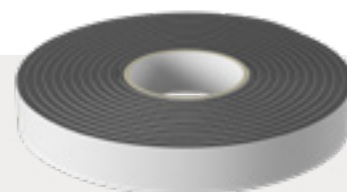

**BANDĂ EXPANDABILĂ IZOLANT**  
(30 X 8/4 MM)

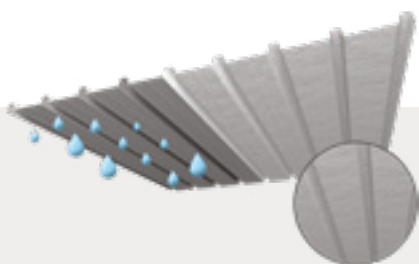

**MEMBRANĂ**  
ANTI-CONDENS

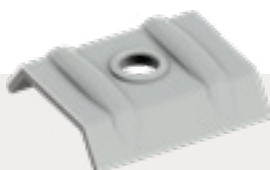

**CALOTE**  
RIGIDIZARE



**BENZI**  
DE ETANȘARE

# ACCESORII

## luminatoare

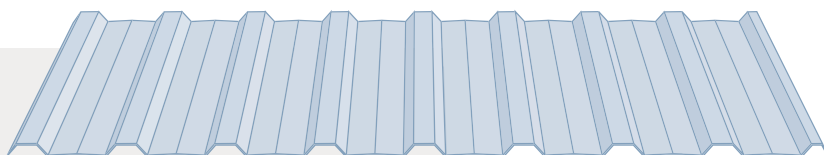

**16,5-137,5-1100**

Poliester 450 g/m<sup>2</sup>  
Lungime: 6 m

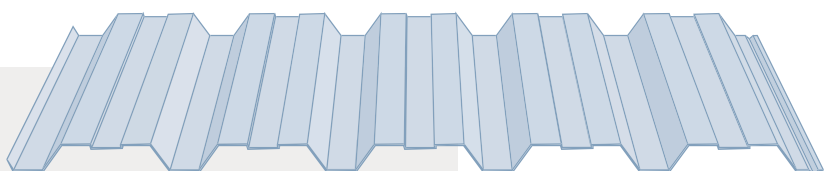

**35-207-1035**

Poliester 450 g/m<sup>2</sup>  
Lungime: 6 m

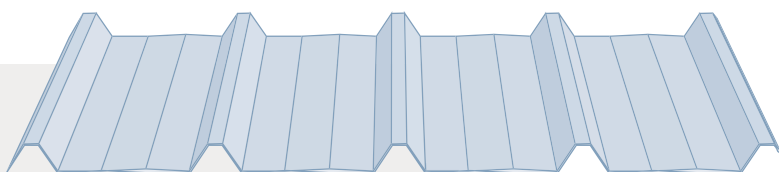

**38-250-1000**

Poliester 450 g/m<sup>2</sup>  
Lungime: 6 m

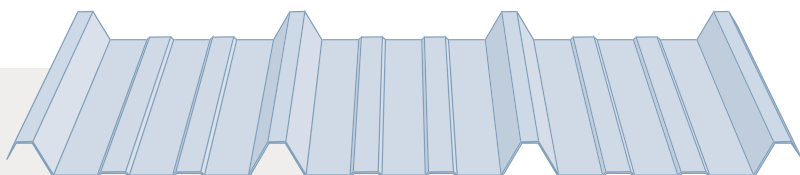

**45-333-1000**

Poliester 450 g/m<sup>2</sup>  
Lungime: 6 m

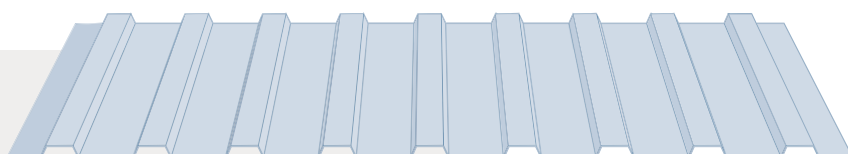

**GRECA**

Poliester 600 g/m<sup>2</sup>  
Lungime: 6 m | 7,6 m

# ACCESORII

metalice de finisaj



COAMĂ CU PANTĂ DUBLĂ

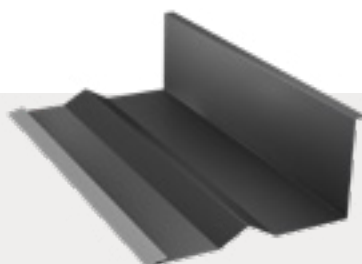

BORDURĂ CALCAN



COAMĂ DREAPTĂ MICĂ

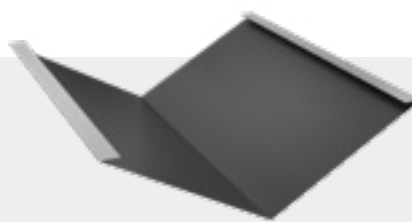

DOLIE



SEMICOAMĂ



BORDURĂ DE FRONTON



SUBCOAMĂ

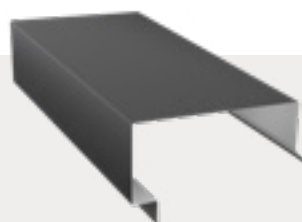

ȘORȚ ATIC



RACORD CALCAN



OPRITOR ZĂPADĂ

# ACCESORII

metalice de finisaj

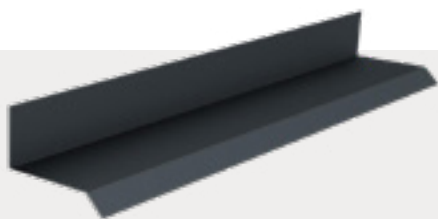

ȘORȚ SOCLU

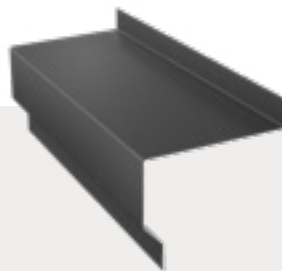

PROFIL GLAF FERESTRE



COLȚAR EXTERIOR



PROFIL BORDARE UȘI



COLȚAR INTERIOR

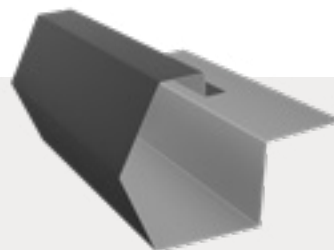

JGHEAB METALIC

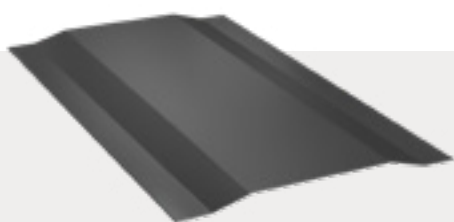

PROFIL ROST

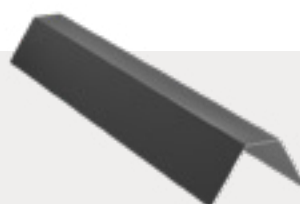

PROFIL FIXARE JGHEAB

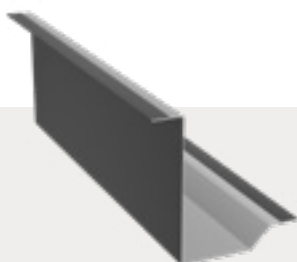

PROFIL BORDARE FERESTRE



CRAPODINĂ

La cerere se pot executa și alte elemente.  
Mai multe detalii puteți obține de la reprezentanții JORIS IDE ROMÂNIA.

# ACCESORII

sistem pluvial

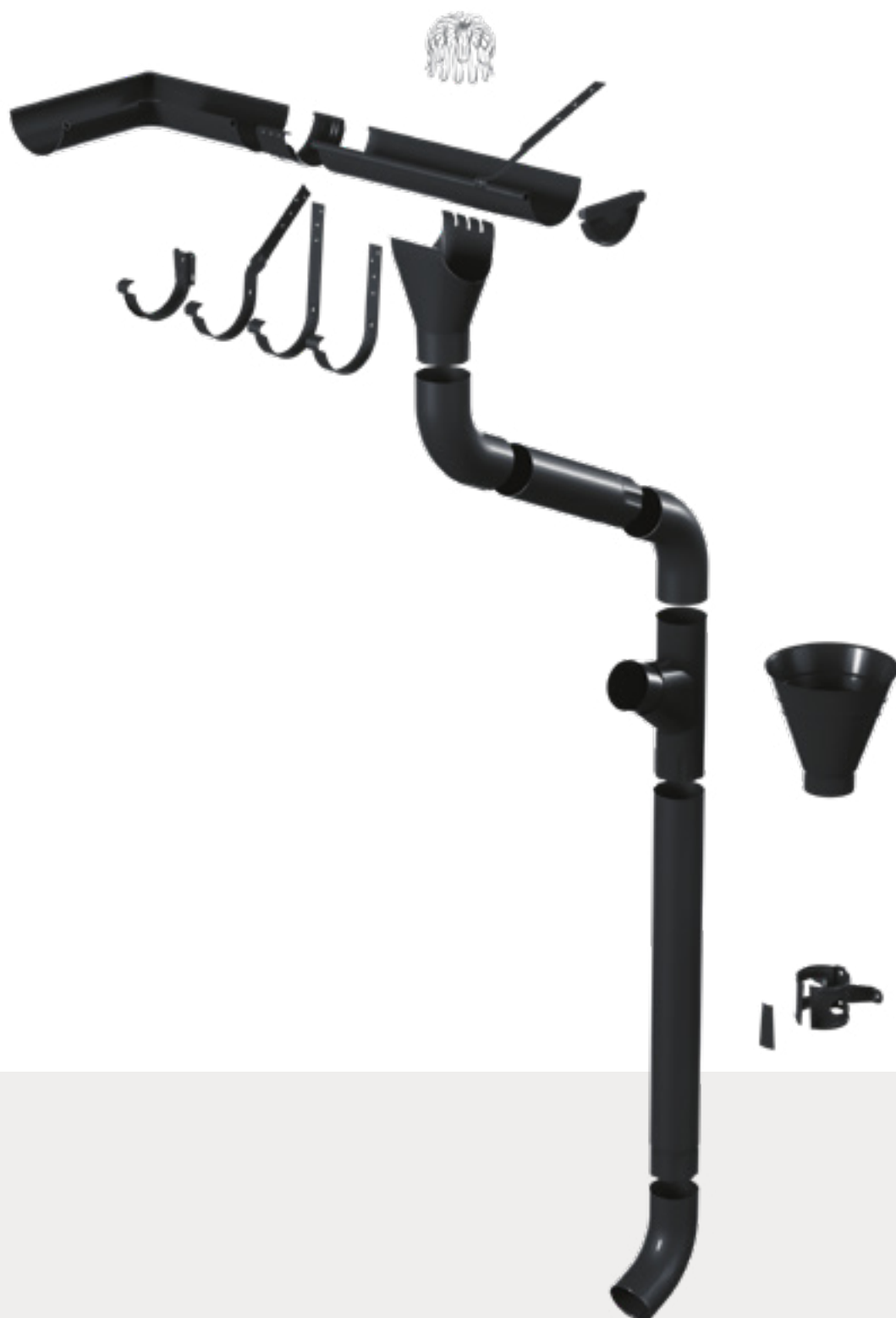

Accesorii și elemente pentru sisteme complete de drenaj a apei pluviale.





Pentru a vă asigura că utilizați cea mai recentă versiune, vă recomandăm să o descărcați de pe site-ul nostru: <https://www.jorisode.ro/downloads> sau scanând acest QR Code.

Acest document nu conferă drepturi și poate suferi modificări. Ne rezervăm dreptul de a modifica documentul fără notificare prealabilă pentru a reflecta progrese sau îmbunătățiri.

#### **JORIS IDE SRL**

Str. Milano nr. 15, Buftea, județul Ilfov  
Str. Principală nr. 58, Buziaș, județul Timiș  
Telefon: 0256 307 700

03-2026-v4